

English Version

**Welding - Fusion-welded joints in steel, nickel, titanium and their alloys (beam welding excluded) - Quality levels for imperfections (ISO 5817:2014)**

Soudage - Assemblages en acier, nickel, titane et leurs alliages soudés par fusion (soudage par faisceau exclu) - Niveaux de qualité par rapport aux défauts (ISO 5817:2014)

Schweißen - Schmelzschweißverbindungen an Stahl, Nickel, Titan und deren Legierungen (ohne Strahlschweißen) - Bewertungsgruppen von Unregelmäßigkeiten (ISO 5817:2014)

This European Standard was approved by CEN on 4 January 2014.

CEN members are bound to comply with the CEN/CENELEC Internal Regulations which stipulate the conditions for giving this European Standard the status of a national standard without any alteration. Up-to-date lists and bibliographical references concerning such national standards may be obtained on application to the CEN-CENELEC Management Centre or to any CEN member.

This European Standard exists in three official versions (English, French, German). A version in any other language made by translation under the responsibility of a CEN member into its own language and notified to the CEN-CENELEC Management Centre has the same status as the official versions.

CEN members are the national standards bodies of Austria, Belgium, Bulgaria, Croatia, Cyprus, Czech Republic, Denmark, Estonia, Finland, Former Yugoslav Republic of Macedonia, France, Germany, Greece, Hungary, Iceland, Ireland, Italy, Latvia, Lithuania, Luxembourg, Malta, Netherlands, Norway, Poland, Portugal, Romania, Slovakia, Slovenia, Spain, Sweden, Switzerland, Turkey and United Kingdom.



EUROPEAN COMMITTEE FOR STANDARDIZATION  
COMITÉ EUROPÉEN DE NORMALISATION  
EUROPÄISCHES KOMITEE FÜR NORMUNG

**CEN-CENELEC Management Centre: Avenue Marnix 17, B-1000 Brussels**

## Foreword

This document (EN ISO 5817:2014) has been prepared by Technical Committee ISO/TC 44 "Welding and allied processes" in collaboration with Technical Committee CEN/TC 121 "Welding" the secretariat of which is held by DIN.

This European Standard shall be given the status of a national standard, either by publication of an identical text or by endorsement, at the latest by August 2014, and conflicting national standards shall be withdrawn at the latest by August 2014.

Attention is drawn to the possibility that some of the elements of this document may be the subject of patent rights. CEN [and/or CENELEC] shall not be held responsible for identifying any or all such patent rights.

This document supersedes EN ISO 5817:2007.

According to the CEN-CENELEC Internal Regulations, the national standards organizations of the following countries are bound to implement this European Standard: Austria, Belgium, Bulgaria, Croatia, Cyprus, Czech Republic, Denmark, Estonia, Finland, Former Yugoslav Republic of Macedonia, France, Germany, Greece, Hungary, Iceland, Ireland, Italy, Latvia, Lithuania, Luxembourg, Malta, Netherlands, Norway, Poland, Portugal, Romania, Slovakia, Slovenia, Spain, Sweden, Switzerland, Turkey and the United Kingdom.

### Endorsement notice

The text of ISO 5817:2014 has been approved by CEN as EN ISO 5817:2014 without any modification.

## Contents

Page

Foreword.....	iv
Introduction.....	v
1 Scope.....	1
2 Normative references.....	1
3 Terms and definitions.....	2
4 Symbols.....	3
5 Assessment of imperfections.....	4
Annex A (informative) Examples of determination of percentage (%) porosity.....	21
Annex B (informative) Additional information and guidelines for use of this International Standard.....	23
Annex C (informative) Additional requirements for welds in steel subject to fatigue.....	24
Bibliography.....	27

## Foreword

ISO (the International Organization for Standardization) is a worldwide federation of national standards bodies (ISO member bodies). The work of preparing International Standards is normally carried out through ISO technical committees. Each member body interested in a subject for which a technical committee has been established has the right to be represented on that committee. International organizations, governmental and non-governmental, in liaison with ISO, also take part in the work. ISO collaborates closely with the International Electrotechnical Commission (IEC) on all matters of electrotechnical standardization.

The procedures used to develop this document and those intended for its further maintenance are described in the ISO/IEC Directives, Part 1. In particular the different approval criteria needed for the different types of ISO documents should be noted. This document was drafted in accordance with the editorial rules of the ISO/IEC Directives, Part 2. [www.iso.org/directives](http://www.iso.org/directives)

Attention is drawn to the possibility that some of the elements of this document may be the subject of patent rights. ISO shall not be held responsible for identifying any or all such patent rights. Details of any patent rights identified during the development of the document will be in the Introduction and/or on the ISO list of patent declarations received. [www.iso.org/patents](http://www.iso.org/patents)

Any trade name used in this document is information given for the convenience of users and does not constitute an endorsement.

For an explanation on the meaning of ISO specific terms and expressions related to conformity assessment, as well as information about ISO's adherence to the WTO principles in the Technical Barriers to Trade (TBT) see the following URL: [Foreword - Supplementary information](#)

The committee responsible for this document is ISO/TC 44, *Welding and allied processes*, Subcommittee SC 10, *Unification of requirements in the field of metal welding*.

This third edition cancels and replaces the second edition (ISO 5817:2003), which has been technically revised. It also incorporates Technical Corrigendum ISO 5817:2003/Cor 1:2006.

Requests for official interpretations of any aspect of this International Standard should be directed to the Secretariat of ISO/TC 44/SC 10 via your national standards body. A complete listing of these bodies can be found at [www.iso.org](http://www.iso.org).

## Introduction

This International Standard should be used as a reference in the drafting of application codes and/or other application standards. It contains a simplified selection of fusion weld imperfections based on the designations given in ISO 6520-1.

Some of the imperfections described in ISO 6520-1 have been used directly and some have been grouped together. The basic numerical referencing system from ISO 6520-1 has been used.

The purpose of this International Standard is to define dimensions of typical imperfections which might be expected in normal fabrication. It may be used within a quality system for the production of welded joints. It provides three sets of dimensional values from which a selection can be made for a particular application. The quality level necessary in each case should be defined by the application standard or the responsible designer in conjunction with the manufacturer, user and/or other parties concerned. The quality level shall be prescribed before the start of production, preferably at the enquiry or order stage. For special purposes, additional details may be prescribed.

The quality levels given in this International Standard provide basic reference data and are not specifically related to any particular application. They refer to types of welded joint in fabrication and not to the complete product or component itself. It is possible, therefore, that different quality levels are applied to individual welded joints in the same product or component.

It would normally be expected that for a particular welded joint the dimensional limits for imperfections could all be covered by specifying one quality level. In some cases, it may be necessary to specify different quality levels for different imperfections in the same welded joint.

The choice of quality level for any application should take account of design considerations, subsequent processing (e.g. surfacing), mode of stressing (e.g. static, dynamic), service conditions (e.g. temperature, environment) and consequences of failure. Economic factors are also important and should include not only the cost of welding but also of inspection, testing and repair.

Although this International Standard includes types of imperfection relevant to the fusion welding processes listed in [Clause 1](#), only those which are applicable to the process and application in question need to be considered.

Imperfections are quoted in terms of their actual dimensions, and their detection and evaluation may require the use of one or more methods of non-destructive testing. The detection and sizing of imperfections is dependent on the inspection methods and the extent of testing specified in the application standard or contract.

This International Standard does not address the methods used for the detection of imperfections. However, ISO 17635 contains a correlation between the quality level and acceptance level for different NDT methods.

This International Standard is directly applicable to visual testing of welds and does not include details of recommended methods of detection or sizing by non-destructive means. It should be considered that there are difficulties in using these limits to establish appropriate criteria applicable to non-destructive testing methods such as ultrasonic, radiographic, eddy current, penetrant, magnetic particle testing and may need to be supplemented by requirements for inspection, examining and testing.

The values given for imperfections are for welds produced using normal welding practice. Requirements for smaller (more stringent) values as stated in quality level B may include additional manufacturing processes, e.g. grinding, TIG dressing.

[Annex C](#) gives additional guidance for welds subject to fatigue.



# Welding — Fusion-welded joints in steel, nickel, titanium and their alloys (beam welding excluded) — Quality levels for imperfections

## 1 Scope

This International Standard provides quality levels of imperfections in fusion-welded joints (except for beam welding) in all types of steel, nickel, titanium and their alloys. It applies to material thickness  $\geq 0,5$  mm. It covers fully penetrated butt welds and all fillet welds. Its principles can also be applied to partial-penetration butt welds.

(Quality levels for beam welded joints in steel are presented in ISO 13919-1.)

Three quality levels are given in order to permit application to a wide range of welded fabrication. They are designated by symbols B, C and D. Quality level B corresponds to the highest requirement on the finished weld.

Several types of loads are considered, e.g. static load, thermal load, corrosion load, pressure load. Additional guidance on fatigue loads is given in [Annex C](#).

The quality levels refer to production and good workmanship.

This International Standard is applicable to

- a) non-alloy and alloy steels,
- b) nickel and nickel alloys,
- c) titanium and titanium alloys,
- d) manual, mechanized and automatic welding,
- e) all welding positions,
- f) all types of welds, e.g. butt welds, fillet welds and branch connections, and
- g) the following welding processes and their sub-processes, as defined in ISO 4063:
  - 11 metal-arc welding without gas protection;
  - 12 submerged-arc welding;
  - 13 gas-shielded metal-arc welding;
  - 14 gas-shielded arc welding with non-consumable tungsten electrodes;
  - 15 plasma arc welding;
  - 31 oxy-fuel gas welding (for steel only).

Metallurgical aspects, e.g. grain size, hardness, are not covered by this International Standard.

## 2 Normative references

The following documents, in whole or in part, are normatively referenced in this document and are indispensable for its application. For dated references, only the edition cited applies. For undated references, the latest edition of the referenced document (including any amendments) applies.

ISO 6520-1:2007, *Welding and allied processes — Classification of geometric imperfections in metallic materials — Part 1: Fusion welding*

### 3 Terms and definitions

For the purposes of this document, the following terms and definitions apply.

- 3.1**  
**quality level**  
description of the quality of a weld on the basis of type, size and amount of selected imperfections
- 3.2**  
**fitness-for-purpose**  
ability of a product, process or service to serve a defined purpose under specific conditions
- 3.3**  
**short imperfections**  
<weld 100 mm long or longer> imperfections whose total length is not greater than 25 mm in the 100 mm of the weld which contains the greatest number of imperfections
- 3.4**  
**short imperfections**  
<weld less than 100 mm long> imperfections whose total length is not greater than 25 % of the length of the weld
- 3.5**  
**systematic imperfections**  
imperfections that are repeatedly distributed in the weld over the weld length to be examined, the size of a single imperfection being within the specified limits
- 3.6**  
**projected area**  
area where imperfections distributed along the volume of the weld under consideration are imaged two-dimensionally
- Note 1 to entry: In contrast to the cross-sectional area, the occurrence of imperfections is dependent on the weld thickness when exposed radiographically (see [Figure 1](#)).
- 3.7**  
**cross-sectional area**  
area to be considered after fracture or sectioning
- 3.8**  
**smooth weld transition**  
even surface with no irregularities or sharpness at the transition between the weld bead and the parent material
- 3.9**  
**fatigue class**  
**FAT<sub>x</sub>**  
classification reference to S-N curve, in which x is the stress range in MPa at  $2 \cdot 10^6$  cycles

Note 1 to entry: Fatigue properties are described by S-N-Curves (Stress-Number of cycle- curves).

Note 2 to entry: See [Annex C](#).



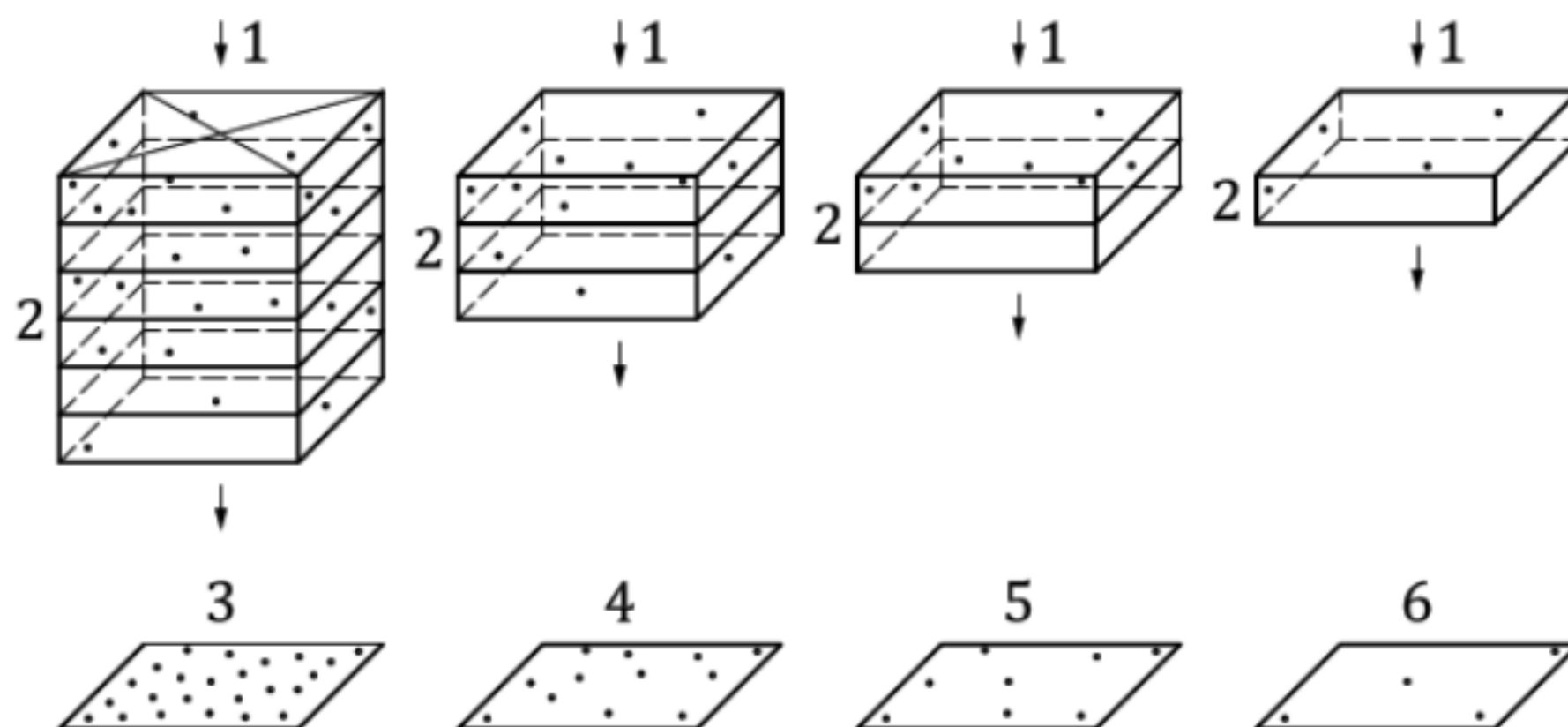

**Key**

- |                           |                    |                    |
|---------------------------|--------------------|--------------------|
| 1 direction of X-rays     | 3 6-fold thickness | 5 2-fold thickness |
| 2 4 pores per volume unit | 4 3-fold thickness | 6 1-fold thickness |

**Figure 1 — Radiographic films of specimens with identical occurrence of pores per volume unit**

## 4 Symbols

The following symbols are used in [Table 1](#) and [Table C.1](#).

- a* nominal throat thickness of the fillet weld (see also ISO 2553)
- A* area surrounding the gas pores
- b* width of weld reinforcement
- d* diameter of gas pore
- d<sub>A</sub>* diameter of area surrounding the gas pores
- h* height or width of imperfection
- l* length of imperfection in longitudinal direction of the weld
- l<sub>p</sub>* length of projected or cross-sectional area
- s* nominal butt weld thickness (see also ISO 2553)
- t* wall or plate thickness (nominal size)
- w<sub>p</sub>* width of the weld or width or height of the cross-sectional area
- z* leg length of a fillet weld (see also ISO 2553)
- α* angle of weld toe
- β* angle of angular misalignment
- i* penetration in fillet welds
- r* radius of weld toe

## 5 Assessment of imperfections

Limits for imperfections are given in [Table 1](#).

If, for the detection of imperfections, macro-examination is used, only those imperfections shall be considered which can be detected with a maximum of tenfold magnification. Excluded from this are micro lack of fusion (see [Table 1](#), 1.5) and microcracks (see [Table 1](#), 2.2).

Systematic imperfections are only permitted in quality level D, provided other requirements of [Table 1](#) are fulfilled.

A welded joint should usually be assessed separately for each individual type of imperfection (see [Table 1](#), 1.1 to 3.2).

Different types of imperfection occurring at any cross-section of the joint need special consideration (see multiple imperfections in [Table 1](#), 4.1).

The limits for multiple imperfections (see [Table 1](#)) are only applicable for cases where the requirements for a single imperfection are not exceeded.

Any two adjacent imperfections separated by a distance smaller than the major dimension of the smaller imperfection shall be considered as a single imperfection.

Table 1 — Limits for imperfections

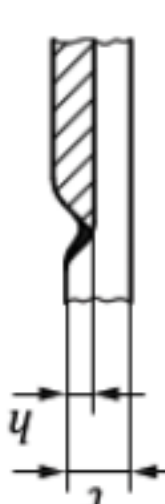
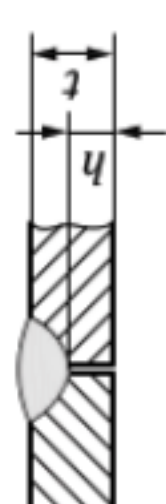
No.	Reference to ISO 6520-1	Imperfection designation	Remarks	t mm	Limits for imperfections for quality levels		
					D	C	B
<b>1 Surface imperfections</b>							
1.1	100	Crack		≥ 0,5	Not permitted	Not permitted	Not permitted
1.2	104	Crater crack		≥ 0,5	Not permitted	Not permitted	Not permitted
1.3	2017	Surface pore	Maximum dimension of a single pore for — butt welds — fillet welds	0,5 to 3	$d \leq 0,3 s$ $d \leq 0,3 a$	Not permitted	Not permitted
			Maximum dimension of a single pore for — butt welds — fillet welds	> 3	$d \leq 0,3 s$ , but max. 3 mm $d \leq 0,3 a$ , but max. 3 mm	$d \leq 0,2 s$ , but max. 2 mm $d \leq 0,2 a$ , but max. 2 mm	Not permitted
1.4	2025	End crater pipe		0,5 to 3 > 3	$h \leq 0,2 t$ $h \leq 0,2 t$ , but max. 2 mm	Not permitted $h \leq 0,1 t$ , but max. 1 mm	Not permitted Not permitted
1.5	401	Lack of fusion (incomplete fusion) Micro lack of fusion	— Only detectable by micro examination	≥ 0,5 ≥ 0,5	Not permitted Permitted	Not permitted Permitted	Not permitted Not permitted
1.6	4021	Incomplete root penetration	Only for single side butt welds 	≥ 0,5	Short imperfections: $h \leq 0,2 t$ but max. 2 mm	Not permitted	Not permitted

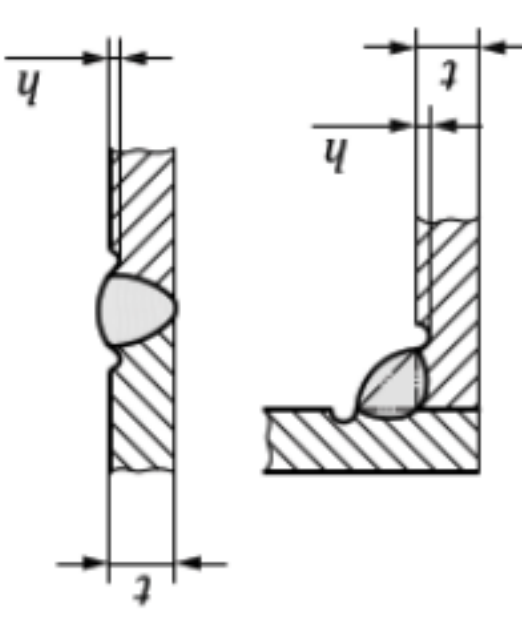
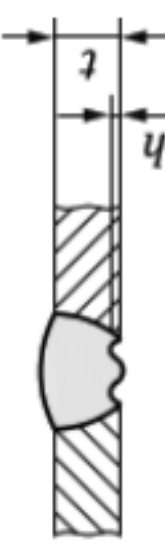
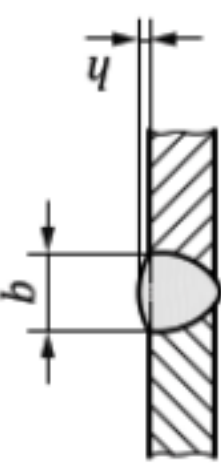
No.	Reference to ISO 6520-1	Imperfection designation	Remarks	t mm	Limits for imperfections for quality levels		
					D	C	B
1.7	5011 5012	Continuous undercut Intermittent undercut	Smooth transition is required. This is not regarded as a systematic imperfection. 	0,5 to 3	Short imperfections: $h \leq 0,1 t$	Not permitted	
				> 3	Short imperfections: $h \leq 0,2 t$ , but max. 1 mm	Short imperfections: $h \leq 0,1 t$ , but max. 0,5 mm $h \leq 0,05 t$ , but max. 0,5 mm	
1.8	5013	Shrinkage groove	Smooth transition is required. 	0,5 to 3	Short imperfections: $h \leq 0,2 \text{ mm} + 0,1 t$	Not permitted	
				> 3	Short imperfections: $h \leq 0,2 t$ , but max. 2 mm	Short imperfections: $h \leq 0,1 t$ Short imperfections: $h \leq 0,1 t$ , but max. 1 mm	
1.9	502	Excess weld metal (butt weld)	Smooth transition is required. 	$\geq 0,5$	Short imperfections: $h \leq 1 \text{ mm} + 0,25 b$ , but max. 10 mm	Short imperfections: $h \leq 1 \text{ mm} + 0,1 b$ , but max. 5 mm	

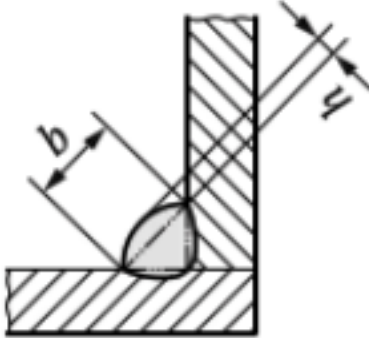
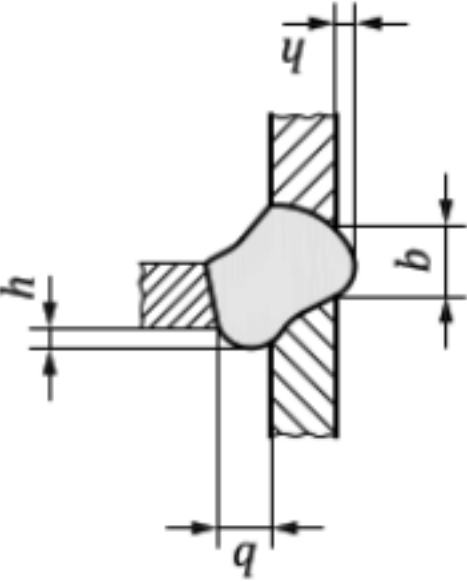
No.	Reference to ISO 6520-1	Imperfection designation	Remarks	t mm	Limits for imperfections for quality levels			
					D	C	B	
1.10	503	Excessive convexity (fillet weld)		≥ 0,5	$h \leq 1 \text{ mm} + 0,25 b$ , but max. 5 mm	$h \leq 1 \text{ mm} + 0,15 b$ , but max. 4 mm	$h \leq 1 \text{ mm} + 0,1 b$ , but max. 3 mm	
1.11	504	Excess penetration		0,5 to 3 > 3	$h \leq 1 \text{ mm} + 0,6 b$ $h \leq 1 \text{ mm} + 1,0 b$ , but max. 5 mm	$h \leq 1 \text{ mm} + 0,3 b$ $h \leq 1 \text{ mm} + 0,6 b$ , but max. 4 mm	$h \leq 1 \text{ mm} + 0,1 b$ $h \leq 1 \text{ mm} + 0,2 b$ , but max. 3 mm	

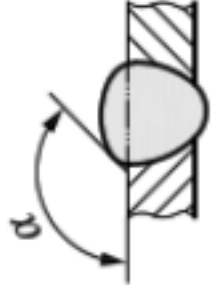
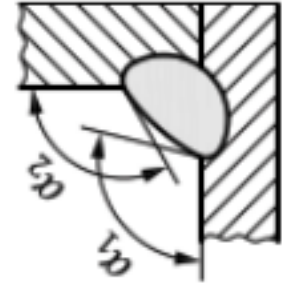
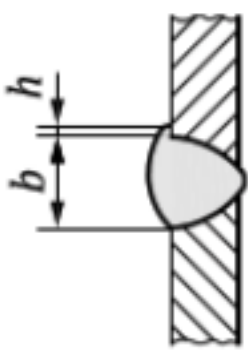
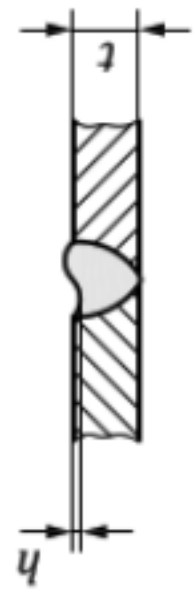
No.	Reference to ISO 6520-1	Imperfection designation	Remarks	t mm	Limits for imperfections for quality levels		
					D	C	B
1.12	505	Incorrect weld toe	 <p>— butt welds</p>	$\alpha \geq 90^\circ$	$\alpha \geq 110^\circ$	$\alpha \geq 150^\circ$	
			 <p>— fillet welds</p> <p><math>\alpha_1 \geq \alpha</math> and <math>\alpha_2 \geq \alpha</math></p>	$\alpha \geq 90^\circ$	$\alpha \geq 100^\circ$	$\alpha \geq 110^\circ$	
1.13	506	Overlap		$\geq 0,5$	$h \leq 0,2 b$	Not permitted	
1.14	509	Sagging	Smooth transition is required	0,5 to 3	Short imperfections: $h \leq 0,25 t$	Short imperfections: $h \leq 0,1 t$	
	511	Incompletely filled groove		$> 3$	Short imperfections: $h \leq 0,25 t$ , but max. 2 mm	Short imperfections: $h \leq 0,1 t$ , but max. 1 mm	

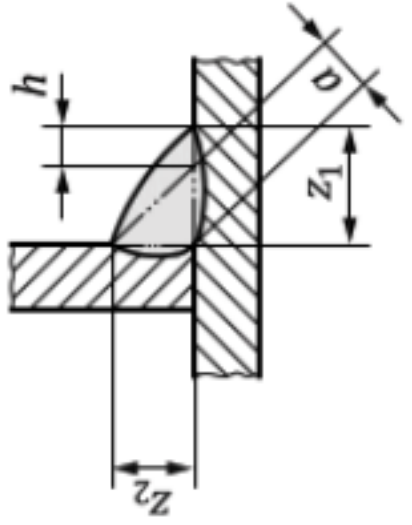
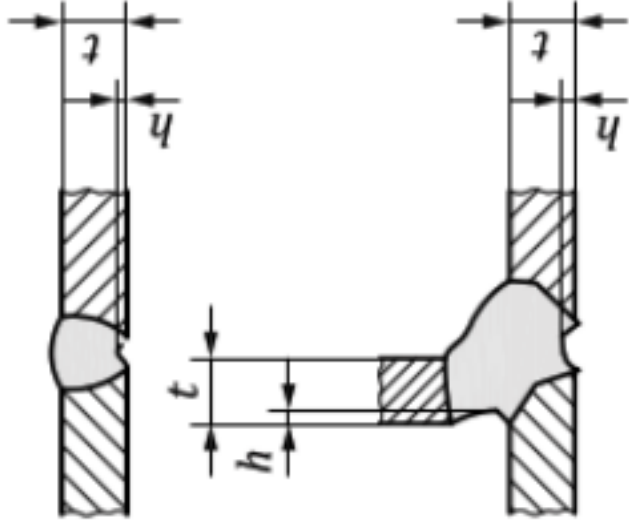
No.	Reference to ISO 6520-1	Imperfection designation	Remarks	t mm	Limits for imperfections for quality levels		
					D	C	B
1.15	510	Burn through	—	≥ 0,5	Not permitted	Not permitted	Not permitted
1.16	512	Excessive asymmetry of fillet weld (excessive unequal leg length)	In cases where an asymmetric fillet weld has not been prescribed. 	≥ 0,5	Not permitted $h \leq 2 \text{ mm} + 0,15 a$	Not permitted $h \leq 1,5 \text{ mm} + 0,15 a$	Not permitted $h \leq 1,5 \text{ mm} + 0,15 a$
1.17	515	Root concavity	Smooth transition is required. 	0,5 to 3  > 3	Not permitted $h \leq 2 \text{ mm} + 0,1 t$  Short imperfections: $h \leq 0,2 t$ , but max. 2 mm	Not permitted  Short imperfections: $h \leq 0,1 t$  Short imperfections: $h \leq 0,1 t$ , but max. 1 mm	Not permitted  Short imperfections: $h \leq 0,05 t$ , but max. 0,5 mm

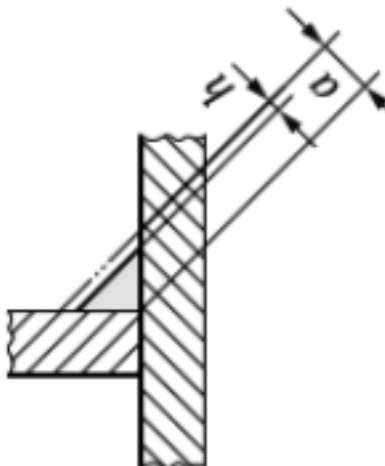
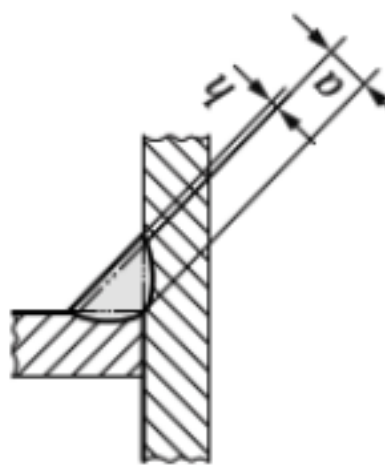
No.	Reference to ISO 6520-1	Imperfection designation	Remarks	t mm	Limits for imperfections for quality levels		
					D	C	B
1.18	516	Root porosity	Spongy formation at the root of a weld due to bubbling of the weld metal at the moment of solidification (e.g. lack of gas backing)	≥ 0,5	Locally permitted	Not permitted	Not permitted
1.19	517	Poor restart	—	≥ 0,5	Permitted The limit depends on the type of imperfection occurred due to restart.	Not permitted	Not permitted
1.20	5213	Insufficient throat thickness	Not applicable to processes with proof of greater depth of penetration 	0,5 to 3	Short imperfections: $h \leq 0,2 \text{ mm} + 0,1 a$	Short imperfections: $h \leq 0,2 \text{ mm}$	Not permitted
				> 3	Short imperfections: $h \leq 0,3 \text{ mm} + 0,1 a$ , but max. 2 mm	Short imperfections: $h \leq 0,3 \text{ mm} + 0,1 a$ , but max. 1 mm	Not permitted
1.21	5214	Excessive throat thickness	The actual throat thickness of the fillet weld is too large. 	≥ 0,5	Permitted	$h \leq 1 \text{ mm} + 0,2 a$ , but max. 4 mm	$h \leq 1 \text{ mm} + 0,15 a$ , but max. 3 mm



No.	Reference to ISO 6520-1	Imperfection designation	Remarks	t mm	Limits for imperfections for quality levels		
					D	C	B
1.22	601	Stray arc	—	≥ 0,5	Permitted, if the properties of the parent metal are not affected.	Not permitted	Not permitted
1.23	602	Spatter	—	≥ 0,5	Acceptance depends on application, e.g. material, corrosion protection	Acceptance depends on application, e.g. material, corrosion protection	Acceptance depends on application, e.g. material, corrosion protection
1.24	610	Temper colour (Discolouration)	—	≥ 0,5	Acceptance depends on application, e.g. material, corrosion protection	Acceptance depends on application, e.g. material, corrosion protection	Acceptance depends on application, e.g. material, corrosion protection

No.	Reference to ISO 6520-1	Imperfection designation	Remarks	t mm	Limits for imperfections for quality levels		
					D	C	B
<b>2 Internal imperfections</b>							
2.1	100	Cracks	All types of crack except microcracks and crater cracks	≥ 0,5	Not permitted	Not permitted	Not permitted
2.2	1001	Microcracks	A crack usually only visible under the microscope (50 ×)	≥ 0,5	Permitted	Acceptance depends on type of parent metal with particular reference to crack sensitivity	Acceptance depends on type of parent metal with particular reference to crack sensitivity
2.3	2011 2012	Gas pore Uniformly distributed porosity	The following conditions and limits for imperfections shall be fulfilled. See also <a href="#">Annex A</a> for information. a1) Maximum dimension of the area of the imperfections (inclusive of systematic imperfection) related to the projected area NOTE The porosity in the project area depends on the numbers of layers (volume of the weld). a2) Maximum dimension of the cross-sectional area of the imperfections (inclusive of systematic imperfection) related to the fracture area (only applicable to test pieces: production test, welder or procedure qualification tests) b) Maximum dimension for a single pore for — butt welds — fillet welds	≥ 0,5	For single layer: ≤ 2,5 % For multi-layer: ≤ 5 %  ≤ 2,5 %	For single layer: ≤ 1,5 % For multi-layer: ≤ 3 %  ≤ 1,5 %	For single layer: ≤ 1 % For multi-layer: ≤ 2 %  ≤ 1 %
				≥ 0,5	d ≤ 0,4 s, but max. 5 mm d ≤ 0,4 a, but max. 5 mm	d ≤ 0,3 s, but max. 4 mm d ≤ 0,3 a, but max. 4 mm	d ≤ 0,2 s, but max. 3 mm d ≤ 0,2 a, but max. 3 mm

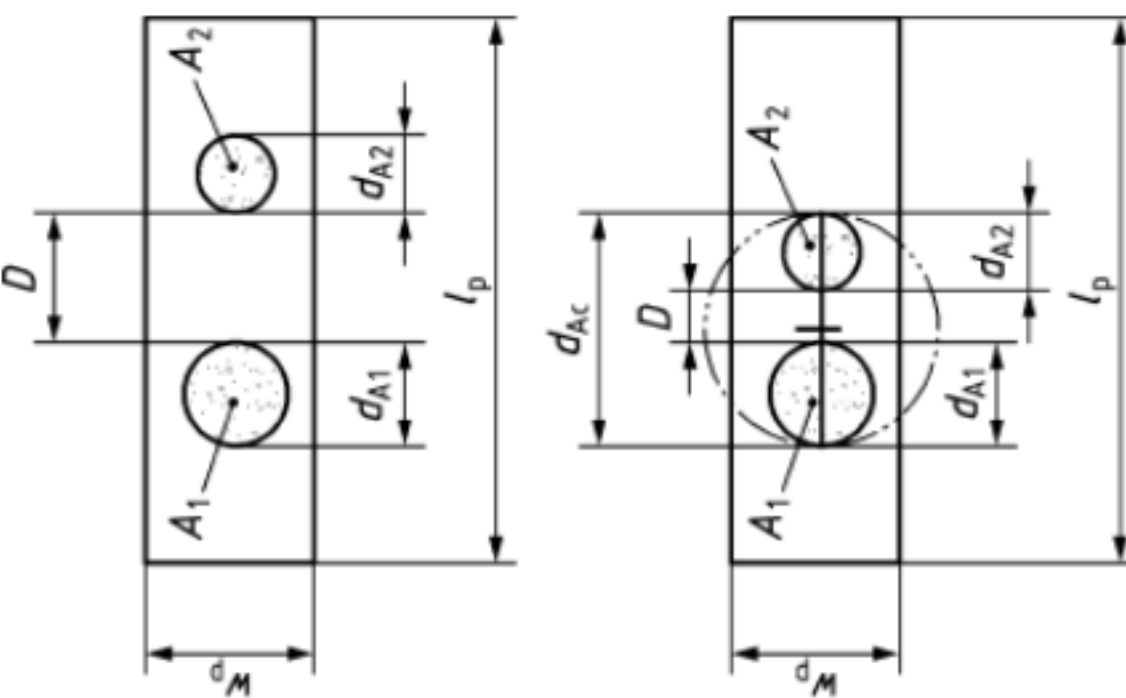
No.	Reference to ISO 6520-1	Imperfection designation	Remarks	t mm	Limits for imperfections for quality levels		
					D	C	B
2.4	2013	Clustered (localized) porosity	 <p>Reference length for <math>l_p</math> is 100 mm.</p> <p>The total gas pore area within the cluster is represented by a circle of diameter <math>d_A</math> surrounding all the gas pores.</p> <p>The requirement for a single gas pore shall be met by all the gas pores within this circle.</p> <p>A permitted porous area shall be local. The possibility of the pore cluster masking other imperfections shall be taken into consideration.</p> <p>If <math>D</math> is less than <math>d_{A1}</math> or <math>d_{A2}</math>, whichever is smaller, then the total gas pore area is represented by a circle of diameter <math>d_{AC}</math>, where <math>d_{AC} = d_{A1} + d_{A2} + D</math>.</p> <p>Systematic cluster porosity is not permitted.</p> <p><math>d_A</math> corresponds to <math>d_{A1}</math>, <math>d_{A2}</math> or <math>d_{AC}</math>, whichever is applicable.</p>	$\geq 0,5$	$d_A \leq 25$ mm or $d_A, \max \leq w_p$	$d_A \leq 20$ mm or $d_A, \max \leq w_p$	$d_A \leq 15$ mm or $d_A, \max \leq w_p/2$

No.	Reference to ISO 6520-1	Imperfection designation	Remarks	t mm	Limits for imperfections for quality levels		
					D	C	B
2.5	2014	Linear porosity	— butt welds	≥ 0,5	$h \leq 0,4 s$ , but max. 4 mm $l \leq s$ , but max. 75 mm	$h \leq 0,3 s$ , but max. 3 mm $l \leq s$ , but max. 50 mm	$h \leq 0,2 s$ , but max. 2 mm $l \leq s$ , but max. 25 mm
			— fillet welds	≥ 0,5	$h \leq 0,4 a$ , but max. 4 mm $l \leq a$ , but max. 75 mm	$h \leq 0,3 a$ , but max. 3 mm $l \leq a$ , but max. 50 mm	$h \leq 0,2 a$ , but max. 2 mm $l \leq a$ , but max. 25 mm
			<p>Case 1 (<math>D &gt; d_2</math>)</p> <p>Case 2 (<math>D &lt; d_2</math>)</p> <p>Reference length for <math>l_p</math> is 100 mm. For case 1: <math>d_1 = h</math> For case 2: <math>d_1 + d_2 + D = h</math></p>				

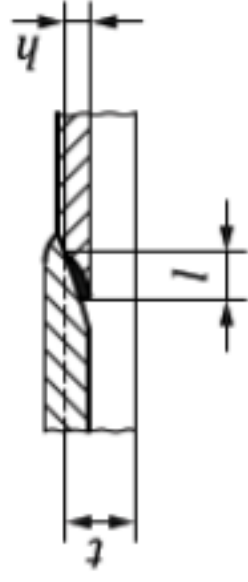
No.	Reference to ISO 6520-1	Imperfection designation	Remarks	t mm	Limits for imperfections for quality levels		
					D	C	B
2.6	2015 2016	Elongated cavity Wormholes	— butt welds	≥ 0,5	$h \leq 0,4s$ , but max. 4 mm $l \leq s$ , but max. 75 mm	$h \leq 0,3s$ , but max. 3 mm $l \leq s$ , but max. 50 mm	$h \leq 0,2s$ , but max. 2 mm $l \leq s$ , but max. 25 mm
			— fillet welds	≥ 0,5	$h \leq 0,4a$ , but max. 4 mm $l \leq a$ , but max. 75 mm	$h \leq 0,3a$ , but max. 3 mm $l \leq a$ , but max. 50 mm	$h \leq 0,2a$ , but max. 2 mm $l \leq a$ , but max. 25 mm
2.7	202	Shrinkage cavity		≥ 0,5	Short imperfections permitted, but not breaking of the surfaces: butt welds: $h \leq 0,4s$ , but max. 4 mm fillet welds: $h \leq 0,4a$ , but max. 4 mm	Not permitted	Not permitted
2.8	2024	Crater pipe		0,5 to 3 > 3	$h$ or $l \leq 0,2t$ $h$ or $l \leq 0,2t$ , but max. 2 mm	Not permitted	Not permitted
2.9	300 301 302 303	Solid inclusions Slag inclusions Flux inclusions Oxide inclusions	The larger value of $h$ or $l$ will be measured — butt welds — fillet welds	≥ 0,5	$h \leq 0,4s$ , but max. 4 mm $l \leq s$ , but max. 75 mm	$h \leq 0,3s$ , but max. 3 mm $l \leq s$ , but max. 50 mm	$h \leq 0,2s$ , but max. 2 mm $l \leq s$ , but max. 25 mm
				≥ 0,5	$h \leq 0,4a$ , but max. 4 mm $l \leq a$ , but max. 75 mm	$h \leq 0,3a$ , but max. 3 mm $l \leq a$ , but max. 50 mm	$h \leq 0,2a$ , but max. 2 mm $l \leq a$ , but max. 25 mm

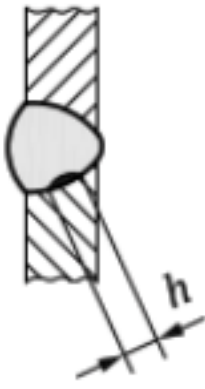
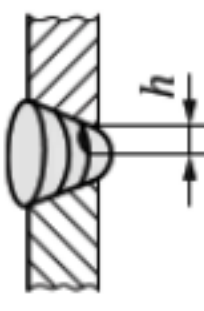
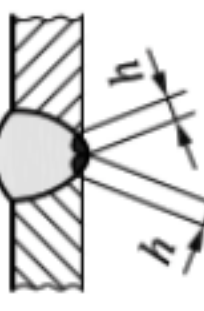
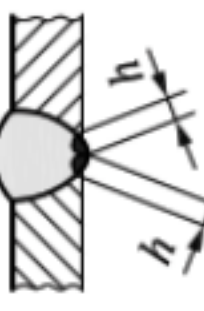
No.	Reference to ISO 6520-1	Imperfection designation	Remarks	t mm	Limits for imperfections for quality levels		
					D	C	B
2.10	304	Metallic inclusions other than copper	— butt welds	≥ 0,5	$h \leq 0,4 s$ , but max. 4 mm	$h \leq 0,3 s$ , but max. 3 mm	$h \leq 0,2 s$ , but max. 2 mm
			— fillet welds		$h \leq 0,4 a$ , but max. 4 mm	$h \leq 0,3 a$ , but max. 3 mm	$h \leq 0,2 a$ , but max. 2 mm
2.11	3042	Copper inclusions	—	≥ 0,5	Not permitted	Not permitted	Not permitted
2.12	401	Lack of fusion (incomplete fusion)		≥ 0,5	Short imperfections permitted: butt welds: $h \leq 0,4 s$ , but max. 4 mm fillet welds: $h \leq 0,4 a$ but max. 4 mm	Not permitted	Not permitted
		Lack of side wall fusion					
	Lack of inter-run fusion						
	Lack of root fusion						
4013		Lack of root fusion					

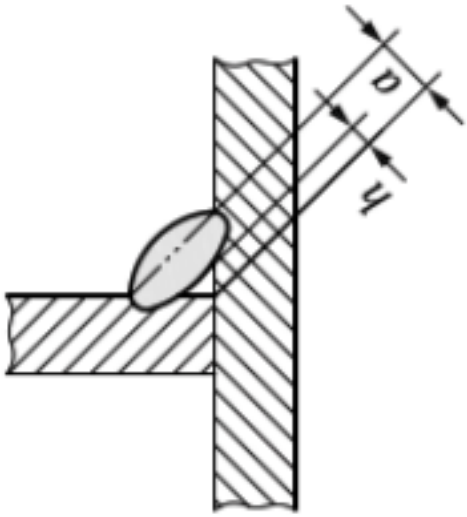
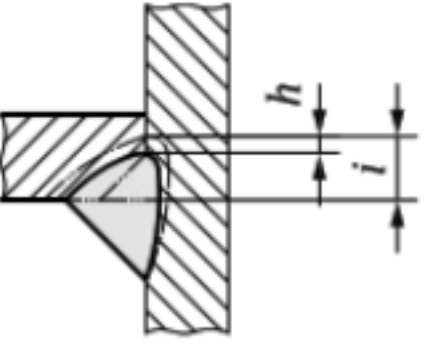
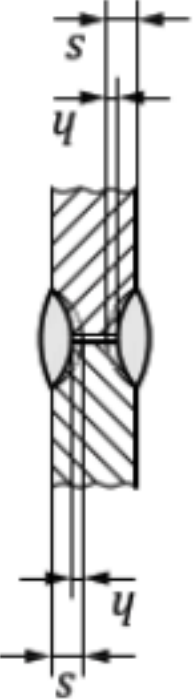
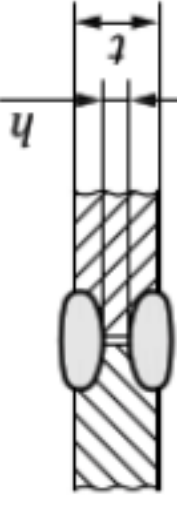
No.	Reference to ISO 6520-1	Imperfection designation	Remarks	t mm	Limits for imperfections for quality levels		
					D	C	B
2.13	402	Lack of penetration	 <p>T-joint (fillet weld)</p>	> 0,5	Short imperfection: $h \leq 0,2 a$ , but max. 2 mm	Not permitted	Not permitted
			 <p>T-joint (partial penetration)</p>  <p>Butt joint (partial penetration)</p>	≥ 0,5	Short imperfections: butt joint: $h \leq 0,2 s$ or $i$ , but max. 2 mm T-joint: $h \leq 0,2 a$ , but max. 2 mm	Short imperfections: butt joint: $h \leq 0,1 s$ or $i$ , but max. 1,5 mm fillet joint: $h \leq 0,1 a$ , but max. 1,5 mm	Not permitted
			 <p>Butt joint (full penetration)</p>	≥ 0,5	Short imperfection: $h \leq 0,2 t$ , but max. 2 mm	Not permitted	Not permitted

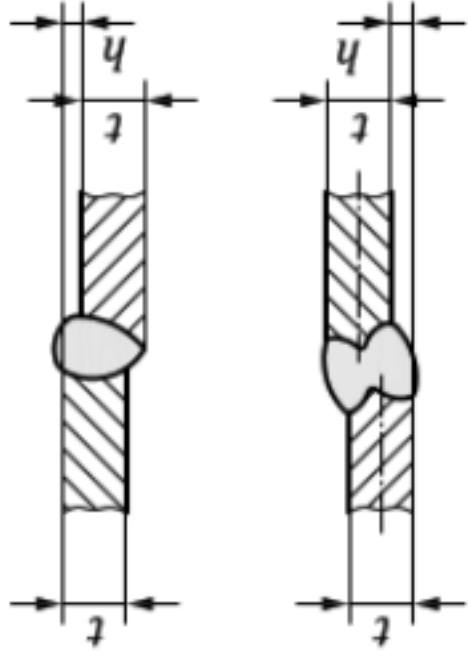
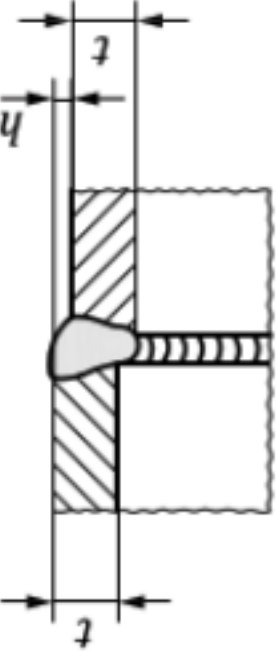
No.	Reference to ISO 6520-1	Imperfection designation	Remarks	t mm	Limits for imperfections for quality levels		
					D	C	B
<b>3 Imperfections in joint geometry</b>							
3.1	507	Linear mis-alignment	The limits relate to deviations from the correct position. Unless otherwise specified, the correct position is that when the centrelines coincide (see also Clause 1). <i>t</i> refers to the smaller thickness.				
	507 1	Linear mis-alignment between plates	 <p>Plates and longitudinal welds</p>	0,5 to 3 > 3	$h \leq 0,2 \text{ mm} + 0,25 t$ $h \leq 0,15 t$ , but max. 4 mm	$h \leq 0,2 \text{ mm} + 0,1 t$ $h \leq 0,1 t$ , but max. 3 mm	
	507 2	Transversely circular welds at cylindrical hollow sections	 <p>Circumferential welds</p>	$\geq 0,5$	$h \leq 0,5 t$ , but max. 4 mm	$h \leq 0,5 t$ , but max. 2 mm	
3.2	617	Incorrect root gap for fillet welds	Gap between the parts to be joined. Gaps exceeding the appropriate limit may, in certain cases, be compensated for by a corresponding increase in the throat thickness.	0,5 to 3 > 3	$h \leq 0,5 \text{ mm} + 0,1 a$ $h \leq 1 \text{ mm} + 0,3 a$ , but max. 4 mm	$h \leq 0,2 \text{ mm} + 0,1 a$ $h \leq 0,5 \text{ mm} + 0,2 a$ , but max. 3 mm	

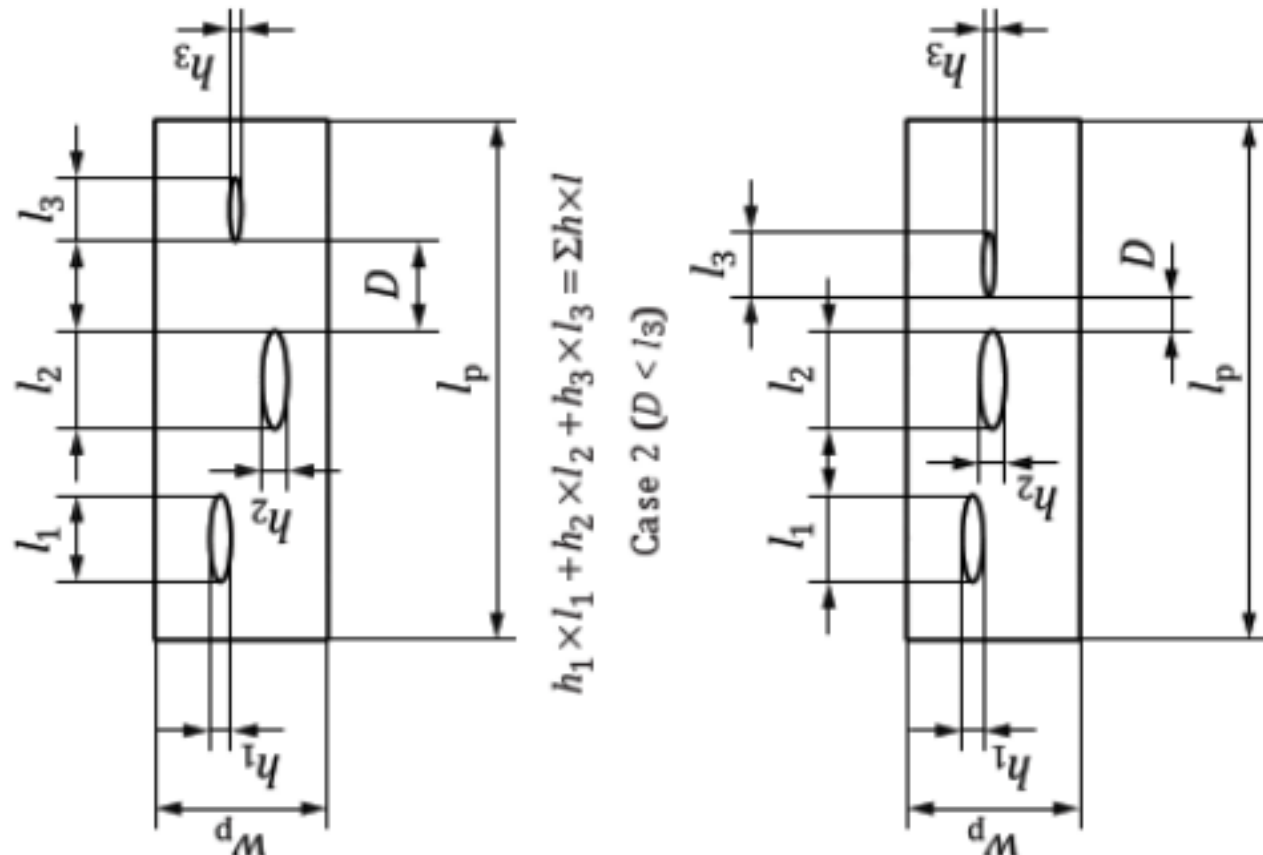

No.	Reference to ISO 6520-1	Imperfection designation	Remarks	t mm	Limits for imperfections for quality levels		
					D	C	B
<b>4 Multiple imperfections</b>							
4.1	None	Multiple imperfections in any cross section	<p> <math>h_1 + h_2 + h_3 + h_4 = \Sigma h</math>  <math>h_1 + h_2 + h_3 = \Sigma h</math> </p>	0,5 to 3 > 3	Not permitted Maximum total height of imperfections: $\Sigma h \leq 0,4 t$ or $\leq 0,25 a$	Not permitted Maximum total height of imperfections: $\Sigma h \leq 0,3 t$ or $\leq 0,2 a$	Not permitted Maximum total height of imperfections: $\Sigma h \leq 0,2 t$ or $\leq 0,15 a$

No.	Reference to ISO 6520-1	Imperfection designation	Remarks	t mm	Limits for imperfections for quality levels		
					D	C	B
4.2	None	Projected or cross-sectional area in longitudinal direction	 <p>Case 1 (<math>D &gt; l_3</math>)</p> $h_1 \times l_1 + h_2 \times l_2 + h_3 \times l_3 = \Sigma h \times l$ <p>Case 2 (<math>D &lt; l_3</math>)</p> $h_1 \times l_1 + h_2 \times l_2 + \left( \frac{h_2 + h_3}{2} \right) \times D + h_3 \times l_3 = \Sigma h \times l$ <p>The sum of the areas <math>\Sigma h \times l</math> shall be calculated as a percentage to the evaluation area <math>l_p \times w_p</math> (case 1).</p> <p>If <math>D</math> is smaller than the shorter length of one of the neighbouring imperfections, the full connection of the two imperfections shall be applied to the sum of imperfections (case 2).</p> <p>See also <a href="#">Annex A</a> for information.</p>	$\geq 0,5$	$\Sigma h \times l \leq 16 \%$	$\Sigma h \times l \leq 8 \%$	$\Sigma h \times l \leq 4 \%$

## Annex A (informative)

### Examples of determination of percentage (%) porosity

[Figures A.1](#) to [A.9](#) give a presentation of different percentage porosities. This should assist the assessment of porosity on projected areas (radiographs) or cross-sectional areas.

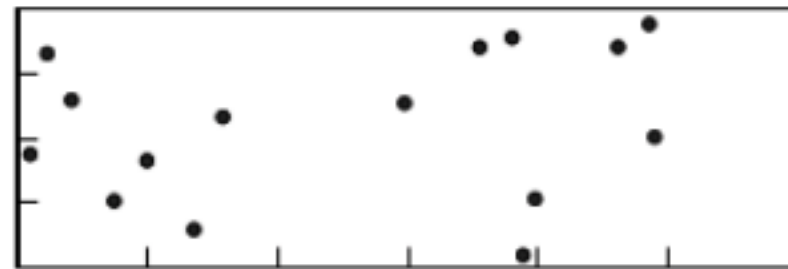

Figure A.1 — 1 surface percent, 15 pores,  $d = 1$  mm

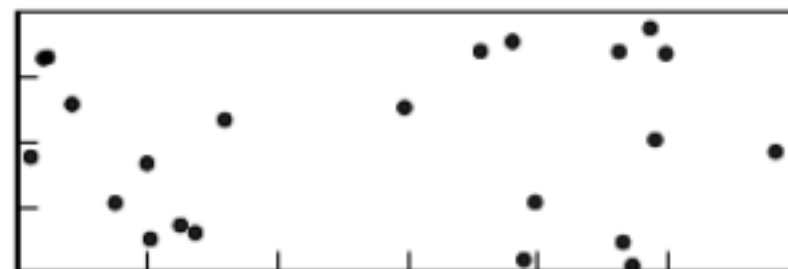

Figure A.2 — 1,5 surface percent, 23 pores,  $d = 1$  mm

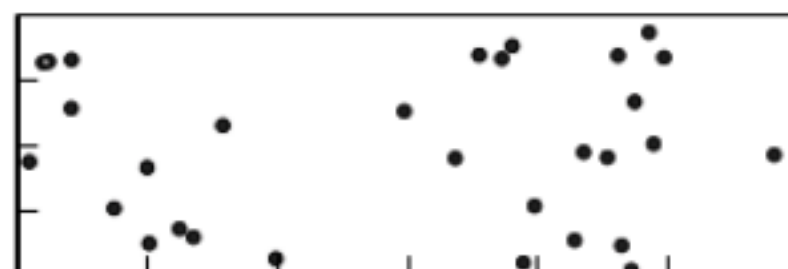

Figure A.3 — 2 surface percent, 30 pores,  $d = 1$  mm

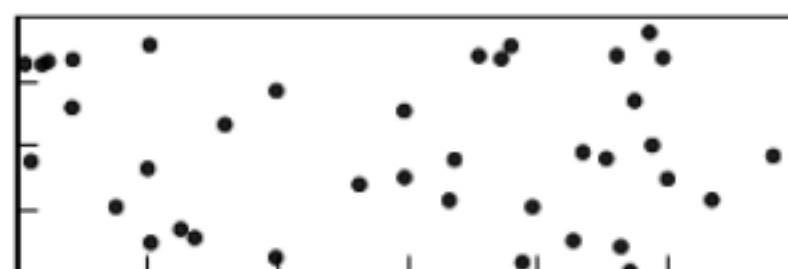

Figure A.4 — 2,5 surface percent, 38 pores,  $d = 1$  mm

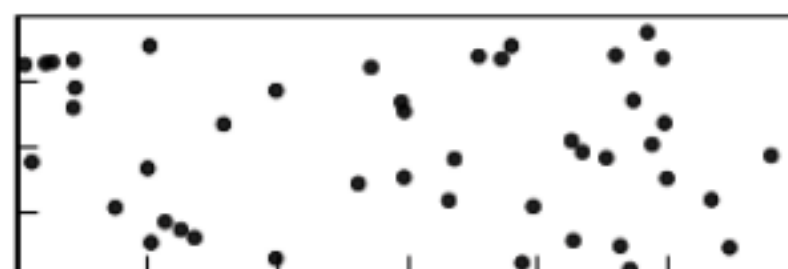

Figure A.5 — 3 surface percent, 45 pores,  $d = 1$  mm

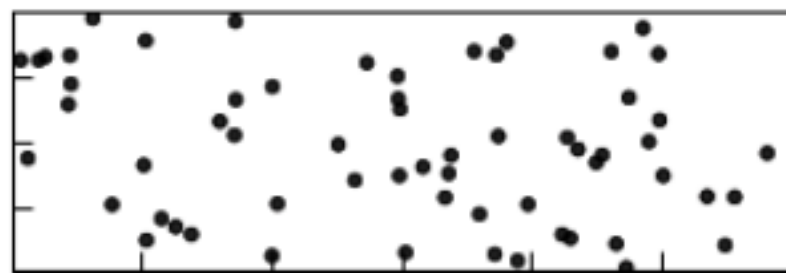

Figure A.6 — 4 surface percent, 61 pores,  $d = 1$  mm



Figure A.7 — 5 surface percent, 76 pores,  $d = 1$  mm



Figure A.8 — 8 surface percent, 122 pores,  $d = 1$  mm

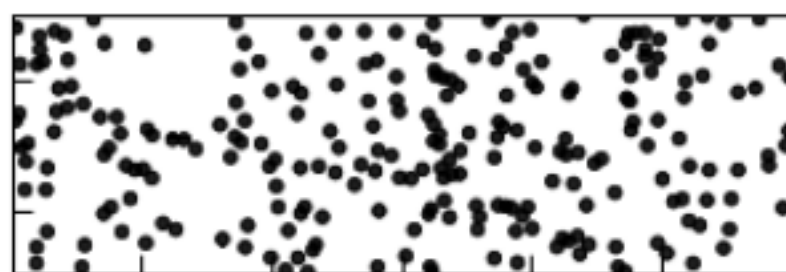

Figure A.9 — 16 surface percent, 244 pores,  $d = 1$  mm

## **Annex B** (informative)

### **Additional information and guidelines for use of this International Standard**

This International Standard specifies requirements for three quality levels for imperfections in welded joints of steel, nickel, titanium and their alloys for fusion welding processes (beam welding excluded) for weld thickness  $\geq 0,5$  mm. It may be used, where applicable, for other fusion welding processes or weld thicknesses.

Different components are very often produced for different applications, but to similar requirements. The same requirements should, however, apply to identical components produced in different workshops to ensure that work is carried out using the same criteria. The consistent application of this international Standard is one of the fundamental cornerstones of a quality management system for use in the production of welded structures.

The summary of multiple imperfections shows a theoretical possibility of superimposed individual imperfections. In such a case, the total summation of all permitted deviations shall be restricted by the stipulated values for the different imperfections, i.e. the limit value of a single imperfection  $\leq h$ , e.g. for a single pore, shall not be exceeded.

This International Standard may be used in conjunction with a catalogue of realistic illustrations showing the size of the permissible imperfections for the various quality levels, by means of photographs showing the face and root side and/or reproductions of radiographs and of photomicrographs showing the cross-section of the weld. An example of such a catalogue is given with "Reference radiographs for the assessment of weld imperfections in accordance with ISO 5817", published by the International Institute of Welding (IIW) and DVS Media Verlag, Düsseldorf. This catalogue may be used with reference cards to assess the various imperfections and may also be used when opinions differ as to the permissible size of imperfections.

## Annex C (informative)

### Additional requirements for welds in steel subject to fatigue

#### C.1 General

This annex gives additional requirements on quality levels in order to meet the fatigue class (FAT) requirement.

The value of fatigue class FAT is the bearable stress range related to 2 million cycles for a two-sided survival probability of 95 % calculated from the mean value on the basis of two-sided 75 % tolerance limits of the mean corresponding to IIW-Recommendation (IIW document IIW-1823-07). IIW-Recommendations contain also information about fatigue classes FAT for different types of welded joints of steel (e.g. butt and fillet welds).

For welds subject to fatigue load, [Table 1](#) shall be supplemented with additional requirements according to [Table C.1](#) and as follows:

#### C.2 Quality levels

The additional requirements for quality level C and B is to adjust the limits for imperfections to the fatigue class FAT 63 for quality level C giving C63 and FAT 90 for quality level B giving B90. A quality level B125 representing fatigue level FAT 125 is represented by additional requirements to level B for some imperfections. Level B125 is not generally achieved as welded. Fillet welds are excluded from Level B125.

NOTE Level C63 cover FAT 63 and lower, level B90 cover FAT 90 and lower, and level B125 cover FAT 125 and lower.

[Table C.1](#) contains additional requirements for level C and B for welds subject to fatigue load. Empty cells in [Table C.1](#) columns for level C and B means that values of [Table 1](#) applies. In the column for level B125 in [Table C.1](#) limits additional to level B requirements are presented. If no limits are presented, level B125 equals requirements for level B.

#### C.3 Smooth transition

For smooth transition in [Table 1](#) transition radius according to No. 1.12 [Table C.1](#) applies.

#### C.4 Partly penetrated butt welds and fillet welds

For partly penetrated butt welds and fillet welds a condition for the limits for imperfection to apply to the respective quality level is that a requirement for the design value of penetration should be fulfilled.

NOTE 1 If no value for the penetration is present, limits for imperfections can be disregarded since the fatigue life will be governed by the design root crack.

NOTE 2 For the quality levels to apply to fatigue levels, FAT, the penetration depth of the inner side of the weld (root side), which is governed by minimum requirements on the drawing, should be determined by appropriate analysis methods and in later stages assessed using inspection.

## C.5 Designation

To indicate that the quality requirement includes the requirements in [Annex C](#) the designation for level B and C is supplemented with the character fatigue class. Level D is not supplemented.

EXAMPLE 1 ISO 5817-C63

EXAMPLE 2 ISO 5817-B90

EXAMPLE 3 ISO 5817-B125

Table C.1 — Additional requirements to [Table 1](#) for welds subject to fatigue load

No.	Reference to ISO 6520-1	Imperfection designation	t mm	Limits for imperfections for quality levels		
				C 63 <sup>c</sup>	B 90 <sup>c</sup>	B 125
1.5	401	Micro lack of fusion	≥ 0,5	a	a	a
1.7	5011 5012	Continuous undercut Intermittent undercut	> 3	a	a	Not permitted
1.8	5013	Shrinkage groove	> 3	a	a	Not permitted
1.9	502	Excess weld metal (butt weld)	≥ 0,5	a	a	$h \leq 0,2 \text{ mm} + 0,1 b$ , max. 2 mm
1.10	503	Excessive convexity (fillet weld)	≥ 0,5	a	a	b
1.11	504	Excess penetration	0,5 to 3	a	a	$h \leq 0,2 \text{ mm} + 0,05 b$
			> 3	a	a	$h \leq 0,2 \text{ mm} + 0,05 b$ , but max. 1 mm
1.12	505	Incorrect weld toe, weld toe angle for fil- let welds	≥ 0,5	a	a	a
—	5052	Incorrect weld toe, weld toe radius  5052 	≥ 0,5	b	b	$r \geq 4 \text{ mm}$
1.14	509 511	Sagging  Incompletely filled groove	> 3	a	a	Not permitted
1.16	512	Excessive asym- metry of fillet weld (excessive unequal leg length)	≥ 0,5	a	a	b
1.17	515	Root concavity	> 3	a	a	Not permitted
1.23	602	Spatter	≥ 0,5	a	a	Not permitted

<sup>a</sup> Same values as given for quality levels B and C respectively [Table 1](#).

<sup>b</sup> Not defined.

<sup>c</sup> Values identical with IIW-Doc. XIII-2323-10. The values are proved by IIW for a material thickness of 10 mm and above. Lower material thicknesses may be applicable.

<sup>d</sup> The limit of imperfection corresponds to the ratio between the sum of the different pore areas and the evaluation area. If the distance between two pore areas is less than the diameter of smallest pore area, an envelope surrounding the both pore areas is relevant as one area of imperfection. If the distance between two pores is smaller than the diameter of one of the neighbouring pores, the full connected area of two pores is the sum of imperfection areas.

Table C.1 (continued)

No.	Reference to ISO 6520-1	Imperfection designation	t mm	Limits for imperfections for quality levels		
				C 63 <sup>c</sup>	B 90 <sup>c</sup>	B 125
2.3	2011 2012	Gas pore Uniformly distributed porosity	≥ 0,5	a	a	for single layer: ≤ 1 % for multi-layer: ≤ 2 % d ≤ 0,1 s, max. 1 mm
2.4	2013	Clustered (localized) porosity	≥ 0,5	a	≤ 3 % <sup>d</sup> d ≤ 0,2 s, d ≤ 0,2 a, d ≤ 2,5 mm	≤ 2 % <sup>d</sup> d ≤ 0,1 s, max. 0,5 mm
2.5	2014	Linear porosity	≥ 0,5	a	a	for single layer: ≤ 1 % <sup>d</sup> for multi-layer: ≤ 2 % <sup>d</sup> d ≤ 0,1 s, max. 1 mm
2.6	2015 2016	Elongation cavity Wormholes	≥ 0,5	a	h ≤ 0,2 s or 0,2 a max. h = 2 mm as welded: max. l = 2,5 mm; stress relieved: l ≤ 20 mm	a
2.9	3 00 3 01 3 02 3 02	Solid inclusions Slag inclusions Flux inclusions Oxide inclusions	≥ 0,5	a	h ≤ 0,2 s or 0,2 a max. h = 2 mm as welded: max. l = 2,5 mm stress relieved: l ≤ 20 mm	Not permitted
3.1	5071	Linear misalignment between plates	≥ 0,5	a	h ≤ 0,1t max. 3 mm	h ≤ 0,05 t max. 1,5 mm
	5072	Transversely circular welds at cylindrical hollow sections	≥ 0,5	a	h ≤ 0,5 t max. 1 mm	a
3.3	508	Angular misalignment <sup>b</sup>	≥ 0,5	β ≤ 2°	β ≤ 1°	β ≤ 1°

<sup>a</sup> Same values as given for quality levels B and C respectively [Table 1](#).

<sup>b</sup> Not defined.

<sup>c</sup> Values identical with IIW-Doc. XIII-2323-10. The values are proved by IIW for a material thickness of 10 mm and above. Lower material thicknesses may be applicable.

<sup>d</sup> The limit of imperfection corresponds to the ratio between the sum of the different pore areas and the evaluation area. If the distance between two pore areas is less than the diameter of smallest pore area, an envelope surrounding the both pore areas is relevant as one area of imperfection. If the distance between two pores is smaller than the diameter of one of the neighbouring pores, the full connected area of two pores is the sum of imperfection areas.



## Bibliography

- [1] ISO 17635, *Non-destructive testing of welds — General rules for metallic materials*
- [2] ISO 2553, *Welding and allied processes — Symbolic representation on drawings — Welded, brazed and soldered joints*
- [3] ISO 4063, *Welding and allied processes — Nomenclature of processes and reference numbers*
- [4] ISO 13919-1, *Welding — Electron and laser-beam welded joints — Guidance on quality levels for imperfections — Part 1: Steel*
- [5] IIW-Catalogue, *Reference radiographs for the assessment of weld imperfections in accordance with ISO 5817*. DVS Media Verlag, Düsseldorf
- [6] HOBACHER A. ed. Recommendations for fatigue design of welded joints and components IIW document XIII-1823-0. Welding Research Council New York, WRC-Bulletin 520, 2009
- [7] HOBACHER A, & KASSNER M On Relation between Fatigue Properties of Welded Joints, Quality Criteria and Groups in ISO 5817. IIW-document XIII-2323-10
- [8] KARLSSON N., & LENANDER P.H. Analysis of fatigue life in two weld class systems, Master thesis in Solid Mechanics, LITH-IKP-EX-05/2302-SE, Linköpings University, Sweden, 2005